

Capacidade de Carga - Load Capacity - Capacidad de carga

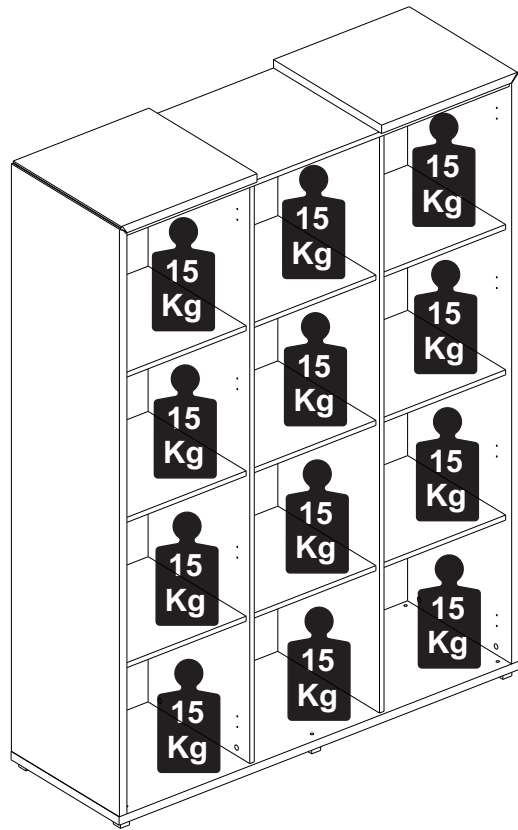

Manutenção e Limpeza

Vidros: pano levemente umedecido com álcool, seguido de pano seco.
Madeiras: pano levemente umedecido com água, seguido de pano seco.
*Nunca utilizar produtos químicos ou abrasivos.

Maintenance and Cleaning

Glasses: cloth lightly moistened with alcohol, followed by dry cloth.
Woods: cloth slightly moistened with water, followed by cloth se.
*Never use chemicals or abrasives.

Mantenimiento y Limpieza

Vidrios: legeramente humedecido con alcohol, seguido de un paño seco.
Madera: ligeramente humedecido con agua, seguido de un paño seco.
*No utilice nunca productos quimicos o abrasivos.

INSTRUÇÕES DE MONTAGEM ASSEMBLY INSTRUCTIONS INSTRUCCIONES DE MONTAJE

ARMÁRIO ALTO ABERTO OPEN HIGH CABINET ARMARIO ALTO ABIERTO

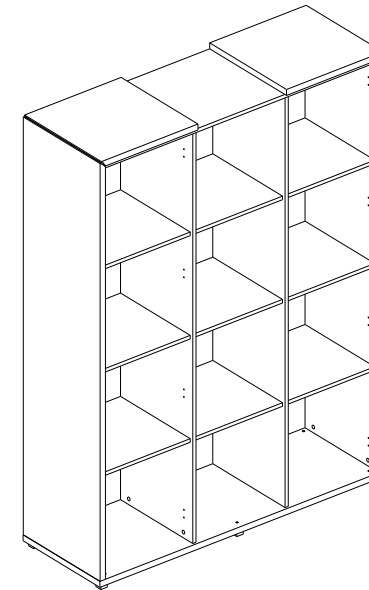

REF. #EDG1318

 **GEBB WORK**
MOBILIÁRIO PARA ESCRITÓRIO

GEBB Work Ind. de Móveis Ltda.
Rua Beatriz Dall'Onder, 120
Distrito Industrial

95706-350 - Bento Gonçalves - RS - Brasil
Fone: (0XX54) 3454-1105 Fax: (0XX54) 3453-1407
Phone: (0XX54) 3454-1105 Fax: (0XX54) 3453-1407
E-mail: pedidos@gebbwork.com.br
www.gebbwork.com.br



LISTA DE PEÇAS

- 01 - Lateral Esquerda
- 02 - Lateral Direita
- 03 - Tampo
- 04 - Base
- 05 - Prateleira Fixa
- 06 - Divisória
- 07 - Tampo Intermediário
- 08 - Costa

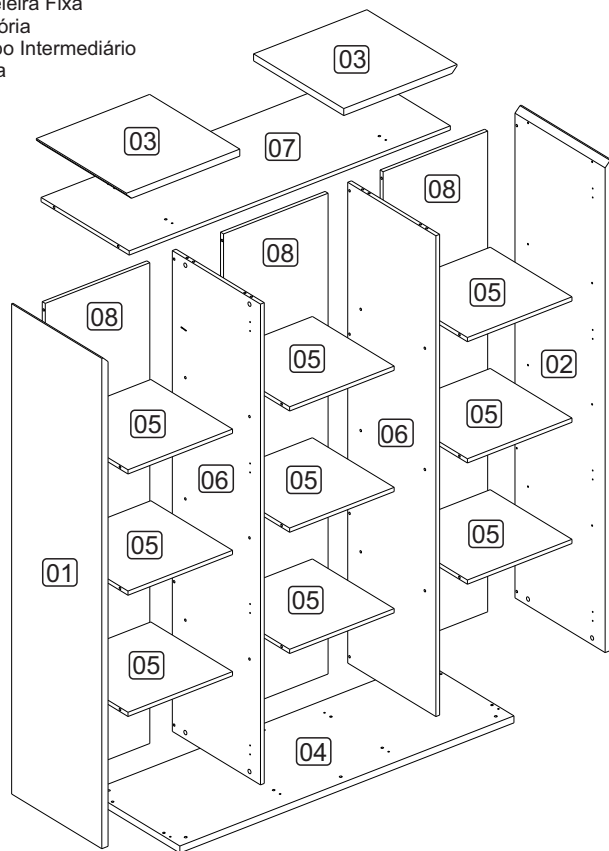

LISTA DE PIEZAS

- 01 - Lateral Izquierda
- 02 - Lateral Derecha
- 03 - Tapa
- 04 - Base
- 05 - Repisa Fija
- 06 - Divisoria
- 07 - Tapa del Medio
- 08 - Revés

PARTS IDENTIFICATION

- 01 - Left Side
- 02 - Right Side
- 03 - Top
- 04 - Base
- 05 - Fixed Shelf
- 06 - Divider
- 07 - Intermediary Top
- 08 - Back

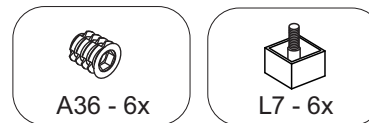
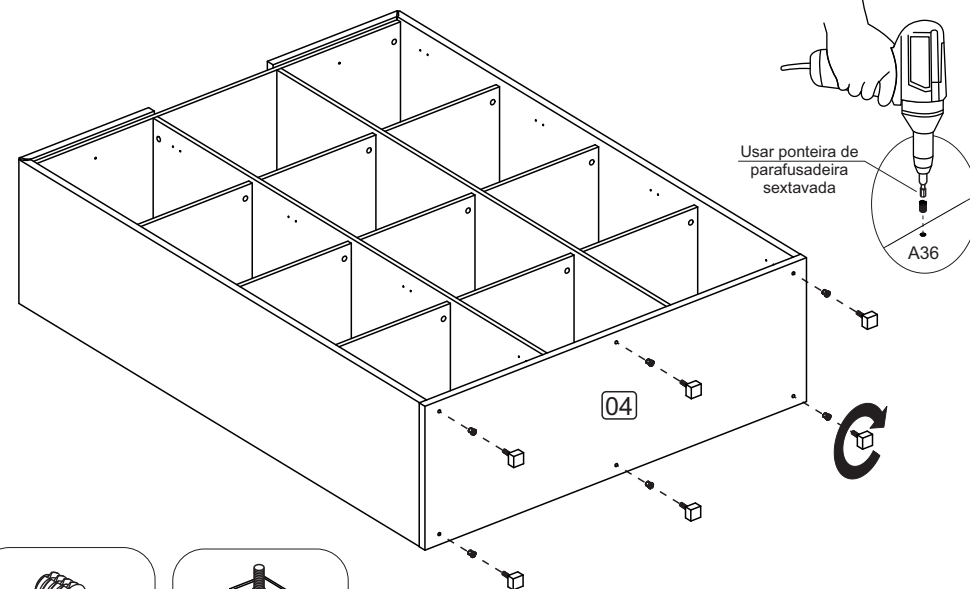
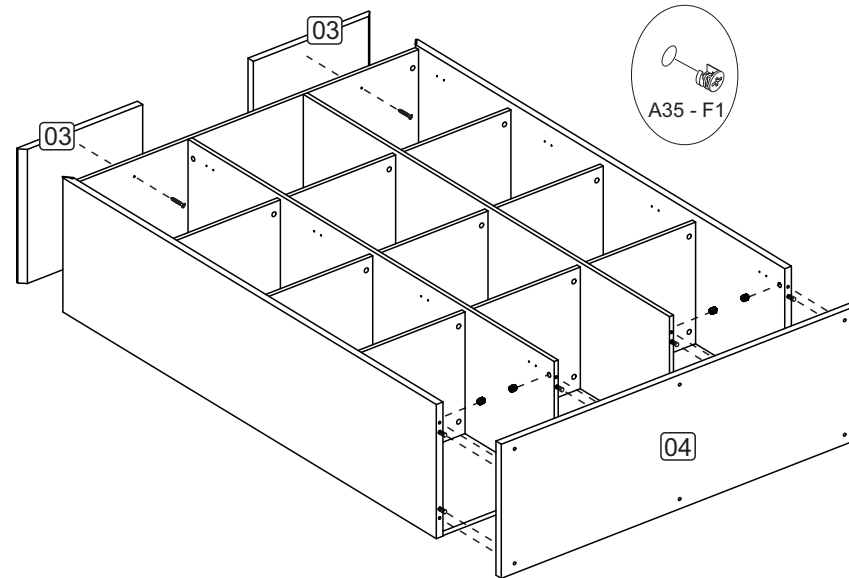

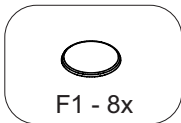
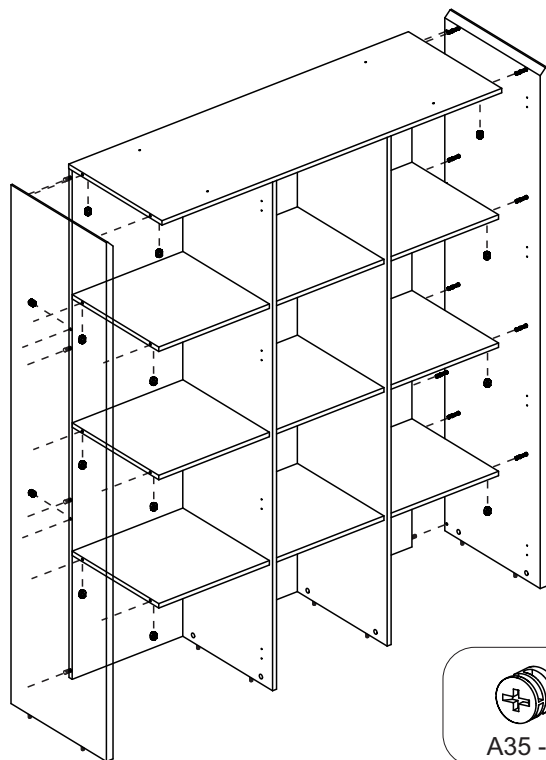
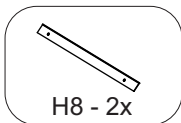
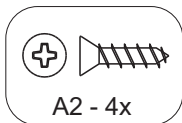
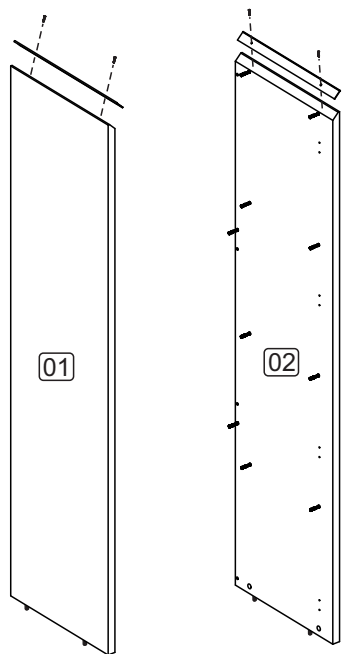

ACESSÓRIOS *ACCESSORIES* *ACCESORIOS*

A2 - PARAF. 3,5x14 CC
4x



A12 - PARAF. 4,0x30 CC
4x



A32 - PARAF. MINIFIX
32x

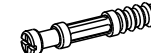

A33 - PARAF. MINIFIX DP
P/15mm **16x**



A35 - TAMBOR
MINIFIX **64x**



D1 - CAVILHA 8x30
20x

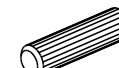

A36 - BUCHA M6x13
6x



D3 - CAVILHA 8x50
8x

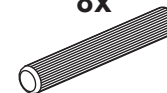

F1 - TAPA FURO ø18
32x



H8 - PERFIL ACABAM.
ALUMÍNIO **2x**

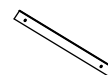

L7 - SAPATA EM ALUMÍNIO
30x30x20mm **6x**



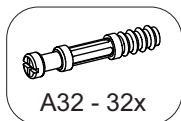
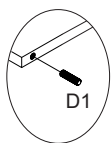
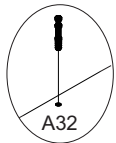
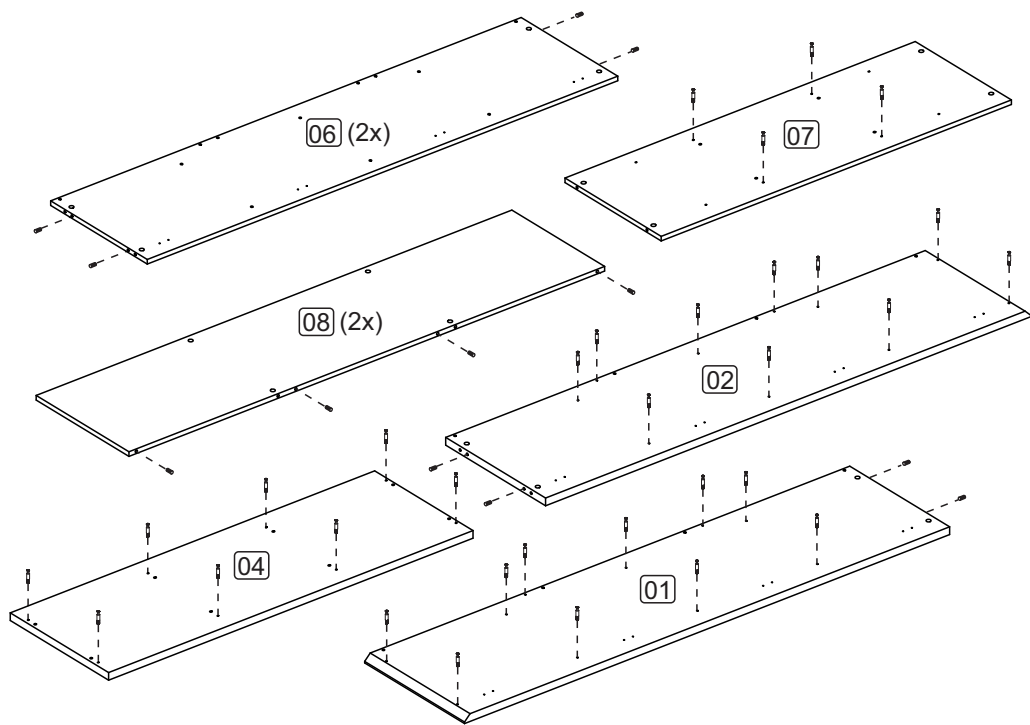

A32 - 32x

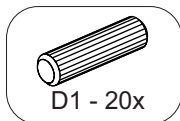

D1 - 20x

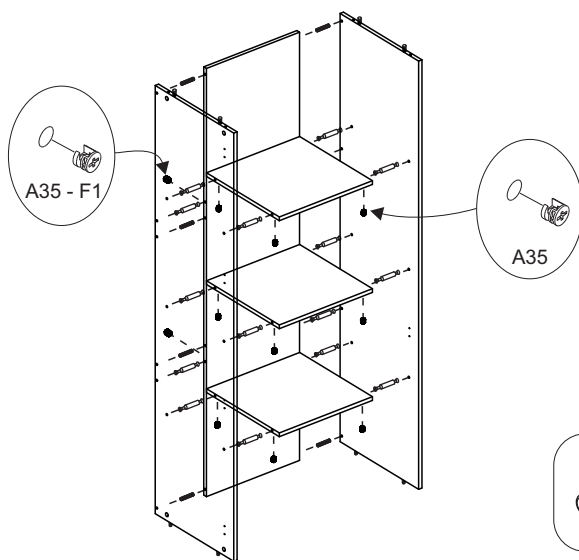

A35

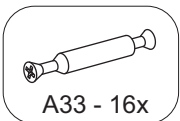

A33 - 16x

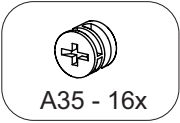

A35 - 16x

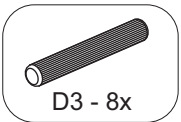

D3 - 8x

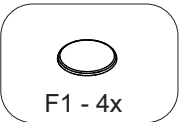

F1 - 4x



A35 - F1



A35 - 16x

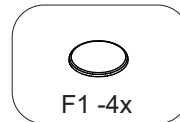

F1 - 4x

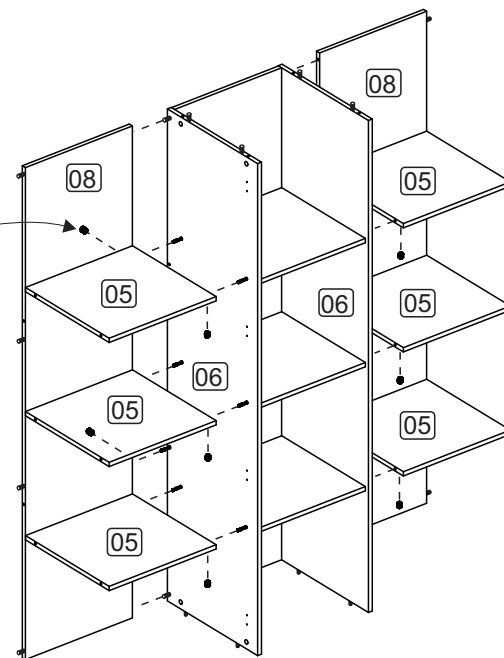

A35



A35 - 4x

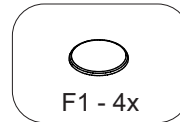

F1 - 4x

